



Rigo®



SYSTEMBOEK

Rigo Metaal



Njordok®



Leverancier en producent van talloze producten en complete bevestigingssystemen.

Al onze producten worden geleverd in onze eigen standaardverpakking voorzien van een duidelijke etikettering.

Maar heeft u speciale wensen inzake verpakking en/of verzending dan komen wij u daarin graag tegemoet.

In deze brochure geven wij slechts een beknopt overzicht van onze mogelijkheden.

Belt u ons voor een afspraak, wij ontvangen u graag in onze showroom. Wij kunnen daar al onze systemen demonstreren en u tonen hoe breed ons pakket producten en diensten is.

Speciaal draaiwerk

In de loop der jaren hebben wij met een behoorlijk aantal klanten meegedacht.

Het resultaat is een enorme ervaring op het gebied van speciaal draaiwerk, zetwerk en buigwerk.

















































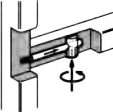

Dit loopt van een variatie op een thema, denk aan een afwijkende maat, een ander soort materiaal of oppervlakte-behandeling tot een volledig nieuw ontwikkeld product.

Ook het produceren van aanloopseries en prototypes ligt binnen onze mogelijkheden.

Wij zijn u graag van dienst





NJORFOK produkten inwendige draad	multimoer  pag. 5	pen voor multimoer  pag. 6	flensmoer bolkop  pag. 7-8	flensmoer platkop  pag. 8-11	flensmoer TGA  pag. 12	binnenzeskant moer  pag. 13	buisstiftmoer  pag. 14	stiftmoer  pag. 15	groefmoer  pag. 16
	rondmoer  pag. 17	SPOR rampa moer  pag. 18	NJORFOK rampa moer  pag. 19	insert  pag. 20	inzetmoer  pag. 20	inslagmoer  pag. 20	draadbus  pag. 21		
NJORFOK produkten uitwendige draad	draadeind  pag. 22	draadeind binnenzeskant  pag. 23	binn.zesk. bout cilinder kop  pag. 24	binn.zesk. bout verzonk. kop  pag. 24	binn. zesk. bout platkop  pag. 25	binn. zesk. bout bolkop  pag. 25	binn. zesk. bout lage bolkop  pag. 25	stokschroef  pag. 26	houtschroef binnenzeskant  pag. 26
	cups  pag. 27	onderlegging  pag. 28	sluitring veerring  pag. 29	binnenzeskant sleutel  pag. 29	radiusring  pag. 30	achterwandsteun  pag. 31	afstandbus  pag. 32		
NJORFOK produkten Stelvoet	stelvoet 0230  pag. 33	draadbus 0230  pag. 33	stelvoet E10...  pag. 33	hoekstuk  pag. 34	plaat  pag. 34	inslagmoer  pag. 34	dubbele hoek  pag. 35	kunststofvoet  pag. 35	kunststofvoet  pag. 35
	glaslijm- doppen  pag. 36								
SPOR produkten	SPOR principe  pag. 37	montage  pag. 38	stift  pag. 39	prop en buisprop  pag. 39	koppelstift  pag. 39	hoekstift  pag. 40	stelschroef  pag. 40	rampamoer  pag. 40	boormaten  pag. 41-42

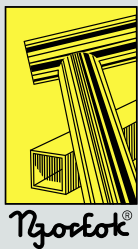

Njorfok Verbindingssystemen

Inwendige draad

MULTIMOEREN



NJORFOK MULTIMOEREN

maken in combinatie met de pen een zeer sterke verbinding aan kops hout mogelijk. (zie ook Pen)

Al deze produkten leveren wij uit voorraad, staal verzinkt. **Code = Bestelnummer**

Andere oppervlakte behandelingen en /of maten op aanvraag.

MULTIMOER montage voorbeeld

maten in mm

Pen voor Multimoer

Multimoer

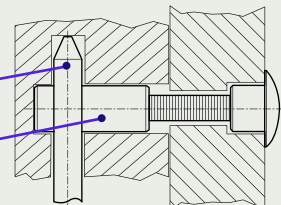

M6 MULTIMOER

M6 x 25

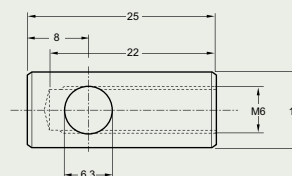

Code: 12000

staal verzinkt

M6 x 36

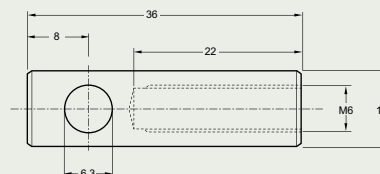

Code: 12002

staal verzinkt

M6 x 50

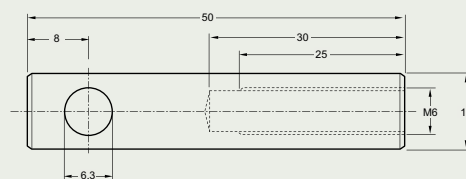

Code: 12003

staal verzinkt

M8 MULTIMOER

M8 x 50

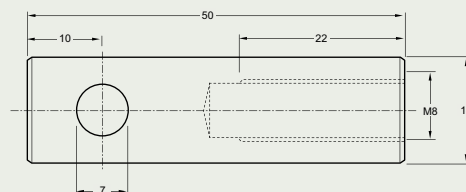

Code: 12005

staal verzinkt

M10 MULTIMOER

M10 x 50

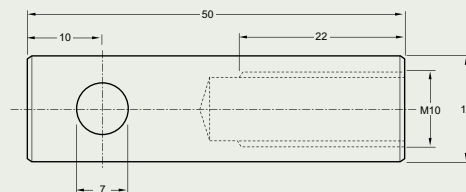

Code: 12011

staal verzinkt

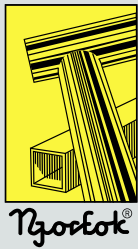

PEN voor MULTIMOER

NJORFOK PEN voor MULTIMOER

maakt in combinatie met onze bekende Multimoer een zeer sterke verbinding aan kops hout mogelijk.
(zie ook Multimoer)

Al deze produkten leveren wij uit voorraad, staal verzinkt. **Code = Bestelnummer**

Andere oppervlakte behandelingen en /of maten op aanvraag.

PEN voor MULTIMOER montage voorbeeld



Pen voor Multimoer

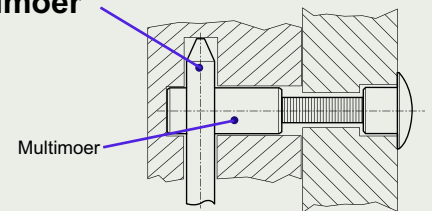

maten in mm

Code	diameter	lengte (L)
15000	6	16
15001	6	18
15002	6	20
15003	6	25
15005	6	30
15007	6	35
15008	6	40
15009	6	45
15010	6	48
15011	6	50
15012	6	55
15013	6	60
15014	6	65
15015	6	70
15027	6	75
15016	6	80
15028	6	85
15017	6	90
15029	6	95
15030	6	100
15031	6	105
15018	6	110
15019	6	115
15020	6	120

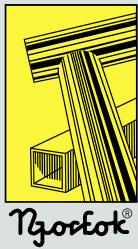

Njorlok Verbindingssystemen

Inwendige draad

FLENSMOEREN

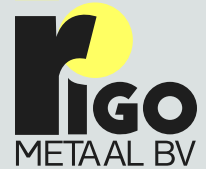

NJORFOK FLENSMOEREN

voldoen aan de hoogste kwaliteitseisen en hebben vele mogelijkheden wat betreft maatvoering, materiaal en oppervlaktebehandeling.

Een groot aantal Njorlok flensmoeren is uit voorraad leverbaar. **Code = Bestelnummer**

Door onze eigen produktiemogelijkheden kunnen wij u ook flensmoeren volgens uw specificaties leveren.

M5 BOLKOP

M5 x 12 bolkop

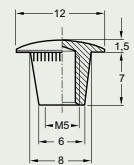

maten in mm

Code: 5028 0195 staal gezwart

M6 BOLKOP

M6 x 15 bolkop

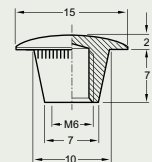

Code: 5027 0146 staal gezwart

M6 x 15 bolkop

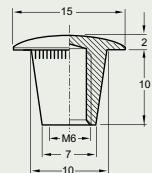

Code: 5254 0320 staal gezwart

M6 BOLKOP binnenzeskant

M6 x 13 bolkop - binnenzeskant

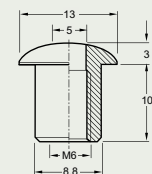

Code: 5036 0379 messing

M6 x 15 bolkop - binnenzeskant

Code: 5006 058 staal gezwart
Code: 5007 058 staal vernikkeld
Code: 5269 058 messing
Code: 5274 058 RVS 303

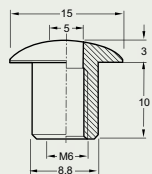

M6 x 15 bolkop - binnenzeskant

Code: 5012 0212 staal gezwart

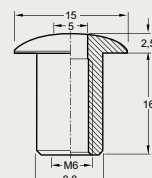

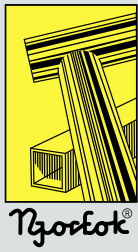

Njorfok Verbindingsystemen

Inwendige draad

FLENSMOEREN

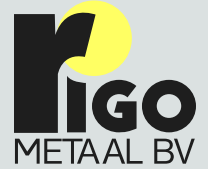

M6 BOLKOP binnenzeskant

Code = Bestelnummer

maten in mm

M6 x 20 bolkop - binnenzeskant

Code: 5015 043 messing
Code: 5015 R043 RVS303

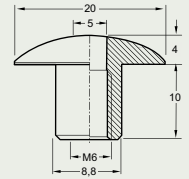

M8 BOLKOP binnenzeskant

M8 x 20 bolkop - binnenzeskant

Code: 5021 072 messing
Code: 5022 072 staal gezwart

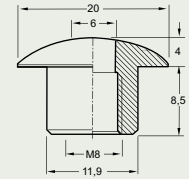

M8 x 20 bolkop - binnenzeskant

Code: 5040 0423 staal gezwart

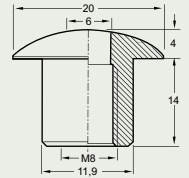

M8 x 24 bolkop - binnenzeskant

Code: 5025 0173 messing

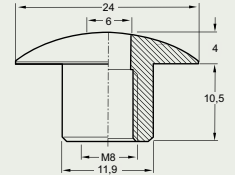

M6 PLATKOP binnenzeskant

M6 x 15 platkop - binnenzeskant

Code: 5014 05 staal gezwart
Code: 5264 05 messing

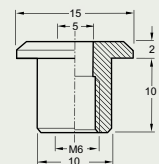

M6 x 15 platkop - binnenzeskant

Code: 5011 013 messing
Code: 5009 013 staal verzinkt
Code: 5010 013 staal gezwart

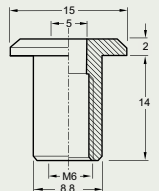

M6 x 16 platkop - binnenzeskant

Code: 1553 0187 staal gezwart

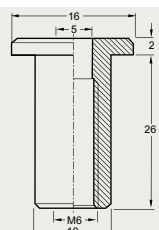

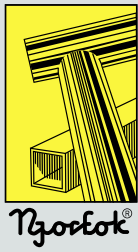

Njorfok Verbindingsystemen

Inwendige draad

FLENSMOEREN

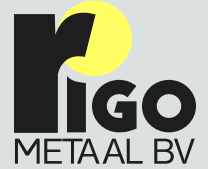

M6 PLATKOP binnenzeskant

Code = Bestelnummer

maten in mm

M6 x 18 platkop - binnenzeskant

Code: 5013 05 staal gezwart
Code: 5013 R05 RVS303

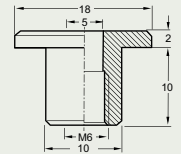

M6 x 20 platkop - binnenzeskant

Code: 5255 0315 staal gezwart

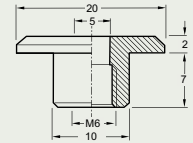

M6 x 20 platkop - binnenzeskant

Code: 5037 0387 staal gezwart

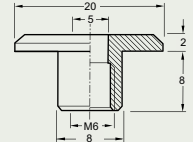

M6 x 20 platkop - binnenzeskant

Code: 5017 090 messing

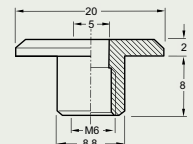

M6 x 20 platkop - binnenzeskant

Code: 5270 0373 staal gezwart

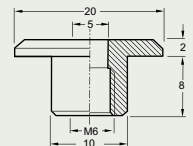

M6 x 20 platkop - binnenzeskant

Code: 5016 05 staal gezwart
Code: 5016 R05 RVS303

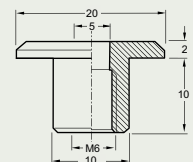

M6 x 20 platkop - binnenzeskant

Code: 5267 0358 staal gezwart

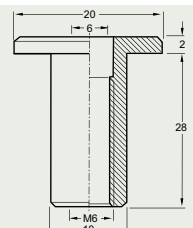

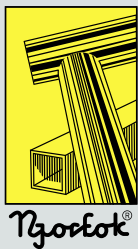

Njorfok Verbindingsystemen

Inwendige draad

FLENSMOEREN



M6 PLATKOP binnenzeskant

Code = Bestelnummer

maten in mm

M6 x 22 platkop - binnenzeskant

Code: 5275 0458 staal gezwart

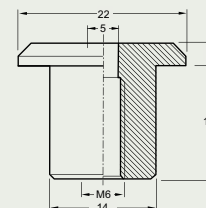

M6 x 24 platkop - binnenzeskant

Code: 5019 0109 staal gezwart

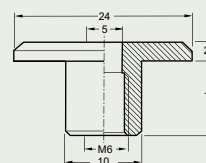

M6 x 25 platkop - binnenzeskant

Code: 5018 024 staal gezwart
Code: 5020 024 messing

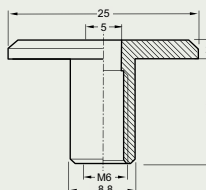

M8 PLATKOP binnenzeskant

M8 x 20 platkop - binnenzeskant

Code: 5023 012 staal gezwart
Code: 5023 R012 RVS303

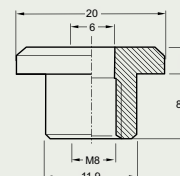

M8 x 20 platkop - binnenzeskant

Code: 5263 0326 staal gezwart

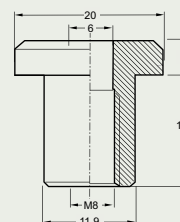

M8 x 20 platkop - binnenzeskant

Code: 5262 0135 staal gezwart
Code: 5268 0135 messing

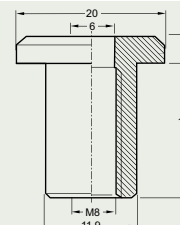

M8 x 24 platkop - binnenzeskant

Code: 5031 0321 staal gezwart
Code: 5031 R0321 RVS303

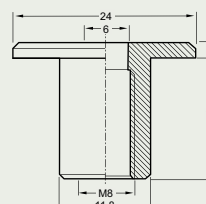

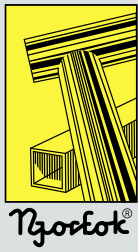

Njorfok Verbindingsystemen

Inwendige draad

FLENSMOEREN

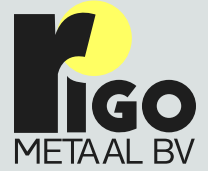

M8 PLATKOP binnenzeskant

Code = Bestelnummer

maten in mm

M8 x 25 platkop - binnenzeskant

Code: 5024 073 staal gezwart

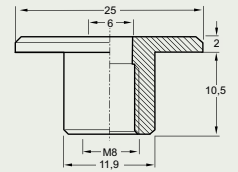

M8 x 25 platkop - binnenzeskant

Code: 5265 0341 staal gezwart

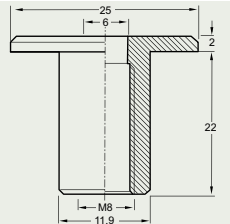

M8 x 26 platkop - binnenzeskant

Code: 5266 0342 staal gezwart

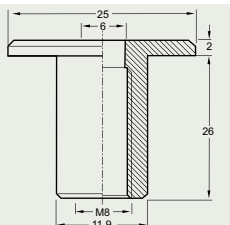

M8 x 40 platkop - binnenzeskant

Code: 5280 0389 messing

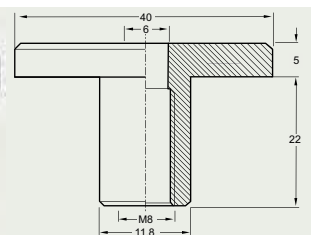

M10 PLATKOP binnenzeskant

M10 x 22 platkop - binnenzeskant

Code: 5043 0497 staal gezwart

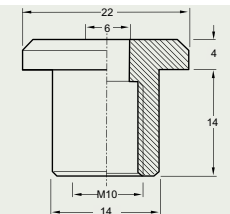

M10 x 22 platkop - binnenzeskant

Code: 5026 016 staal verzinkt
Code: 5042 016 messing
Code: 5260 016 staal gezwart

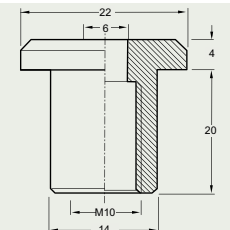

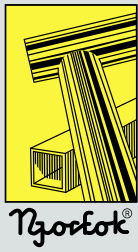

Njorfok Verbindingsystemen

Inwendige draad

TGA-FLENSMOEREN

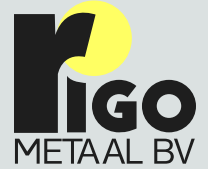

M6 PLATKOP TGA

M6 x 20 platkop -TGA

Code = Bestelnummer

maten in mm

Code: TGAM6 RVS 303

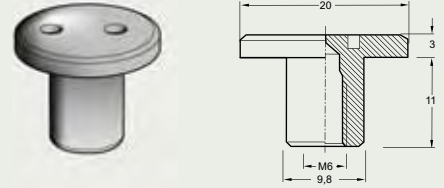

M8 PLATKOP TGA

M8 x 20 platkop - TGA

Code: TGAM8 RVS 303

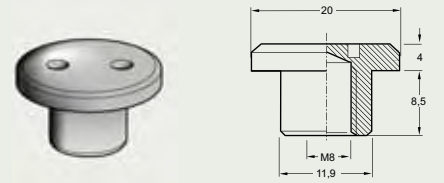

GEREEDSCHAP TGA

Sleutel - TGA

Code: TGASW6 42CRM04

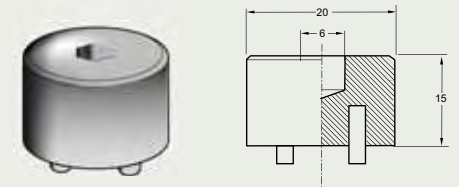

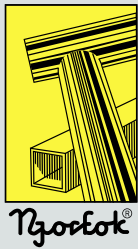

Njorlok Verbindingssystemen

Inwendige draad

BINNENZESKANTMOEREN

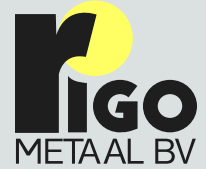

NJORLOK BINNENZESKANTMOER

is samen met een draadeind of bout de ideale manier van bevestigen door een buiswand.
Maar ook op plaatsen waar een uitwendig zeskant niet toepasbaar is.

Al deze produkten leveren wij uit voorraad, staal gezwart. **Code = Bestelnummer**

Andere oppervlakte behandelingen en /of maten op aanvraag.

BINNENZESKANTMOER montage voorbeeld

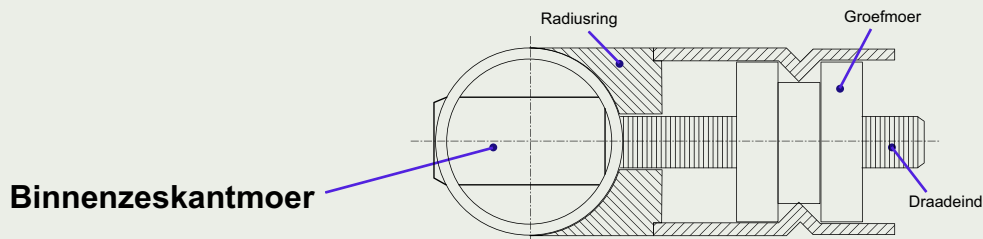

maten in mm

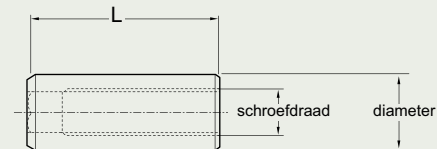

	Code	schroefdraad	lengte (L)	diameter
M6	1001	M 6	13	10
	1003	M 6	15	10
	1004	M 6	16	10
	1031	M 6	17	10
	1006	M 6	18	10
	1008	M 6	19	10
	1010	M 6	20	10
	1012	M 6	21	10
	1014	M 6	22	10
	1032	M 6	23	10
	1017	M 6	25	10
	1018	M 6	26	10
	1020	M 6	28	10
	1030	M 6	29	10
1022	M 6	30	10	
1041	M 6	36	10	
M8	1023	M 6	38	10
	1037	M 8	17	12
	1035	M 8	23,5	12
	1024	M 8	27,5	12
	1025	M 8	29	12
	1036	M 8	36,5	12
	1027	M 8	39	12

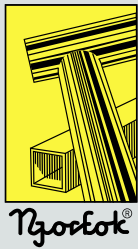

Njorlok Verbindingssystemen

Inwendige draad

BUISSTIFTMOEREN

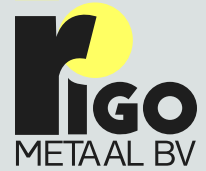

NJORFOK BUISSTIFTMOEREN

geven een solide verbinding en zijn speciaal ontwikkeld voor profielbuizen, zoals: vierkant, ovaal, en rechthoekig.

Al deze producten leveren wij uit voorraad. **Code = Bestelnummer**

Andere oppervlakte behandelingen en /of maten op aanvraag.

BUISSTIFTMOER montage voorbeeld

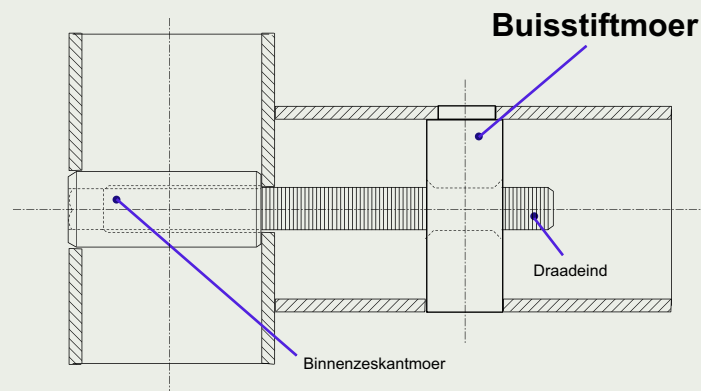

maten in mm

M6 BUISSTIFTMOER

Code	diameter	M6	Lengte (L)
1601	12	M6	16
1602	12	M6	20
1603	12	M6	25
1611	12	M6	40

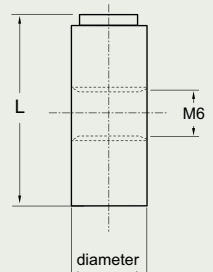

2 x M6 BUISSTIFTMOER

Code	2 x M6	steekmaat 12
1607	gezwart	
1608	verzinkt	

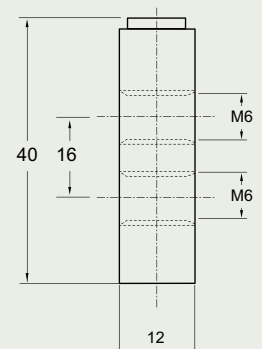

Wij leveren u ook snel elke gewenste buisstiftmoer met 2 gaten en garanderen een moeiteloze montage door de nauwkeurigheid van de steekmaat

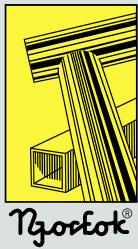

Njorfok Verbindingssystemen

Inwendige draad

STIFTMOEREN

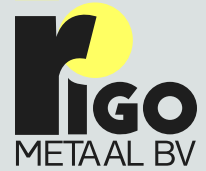

NJORFOK STIFTMOER

Maatnauwkeurigheid is bij stiftmoeren van het allergrootste belang omdat het de verwerkbaarheid sterk beïnvloed. NJORFOK stiftmoeren zijn gegarandeerd aan de maat door onze intensieve eindcontrole.

Al deze producten leveren wij uit voorraad, staal blank. **Code = Bestelnummer**

Andere oppervlakte behandelingen en /of maten op aanvraag.

STIFTMOER montage voorbeeld

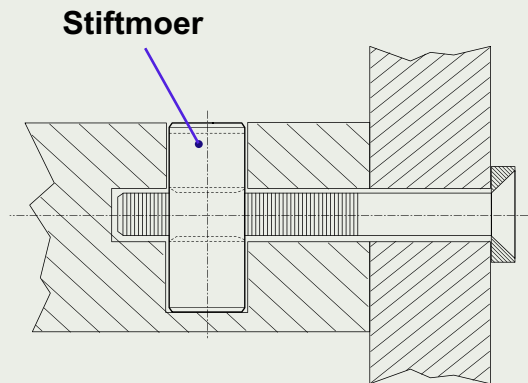
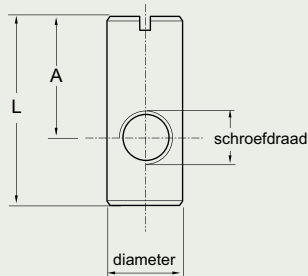

maten in mm

	Code	diameter	lengte (L)	A	schroefdraad
M6	17051	10	12	6	M6
	17052	10	13	8	M6
	17000	10	14	8	M6
	17053	10	14	9	M6
	17054	10	15	7,5	M6
	17055	10	15	9	M6
	17056	10	16	8	M6
	17057	10	16	10	M6
	17001	10	17	11	M6
	17058	10	18	9	M6
	17059	10	18	12	M6
	17060	10	20	10	M6
	17061	10	22	11	M6
	17003	10	25	12,5	M6
	17025	10	25	15	M6
	17062	10	30	15	M6
	17004	10	30	20	M6
	17063	10	35	17,5	M6
	17064	10	35	25	M6
	17065	10	40	20	M6
17066	10	45	22,5	M6	
17067	10	50	25	M6	

	Code	diameter	lengte (L)	A	schroefdraad
M8	17068	12	12	6	M8
	17069	12	14	7	M8
	17070	12	16	8	M8
	17071	12	18	9	M8
	17008	12	20	10	M8
	17072	12	25	12,5	M8
	17073	12	30	15	M8
	17074	12	35	17,5	M8
	17029	12	40	20	M8
	17075	12	45	22,5	M8
17076	12	50	25	M8	
M10	17077	16	20	10	M10
	17078	16	25	12,5	M10
	17050	16	30	15	M10
	17079	16	40	20	M10
	17081	16	50	25	M10

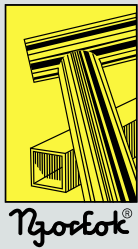

Njorlok Verbindingssystemen

Inwendige draad

GROEFMOEREN



NJORLOK GROEFMOER

De snelste methode om een moer in een ronde buis te plaatsen. Leverbaar voor elke afmeting buis.

Al deze producten leveren wij uit voorraad, staal blank. **Code = Bestelnummer**

Andere oppervlakte behandelingen en /of maten op aanvraag.

GROEFMOER montage voorbeeld

maten in mm

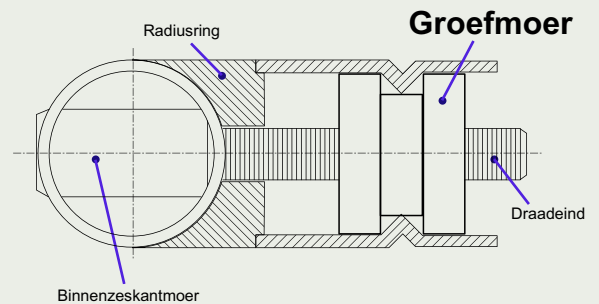
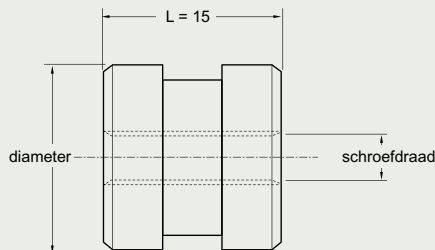

De benodigde universele stempel, passend voor elke afmeting buis, wordt eveneens door ons geleverd. Past in elke pers of zelfs in de bankschroef voor kleinere series. **Stempel Code 12200**

	Code	Schroefdraad	Diameter
M6	6004	M6	11,8
	6006	M6	12,3
	6007	M6	12,8
	6008	M6	13,3
	6009	M6	13,8
	6042	M6	14,8
	6010	M6	15,3
	6011	M6	15,8
	6012	M6	16,4
	6013	M6	16,8
	6014	M6	17,8
	6015	M6	18,8
	6049	M6	19,4
	6043	M6	20,8
	6017	M6	21,8
	6019	M6	22,3
	6020	M6	22,8
	6050	M6	24,5
	6029	M6	24,8
	6021	M6	26,8
	6022	M6	28,5

	Code	Schroefdraad	Diameter
M8	6023	M8	15,8
	6045	M8	16,8
	6024	M8	17,8
	6054	M8	18,8
	6025	M8	20,8
	6026	M8	21,8
	6048	M8	22,3
	6068	M8	22,8
	6072	M8	23,8
	6058	M8	24,6
	6069	M8	25,8
	6028	M8	28,5
	6052	M8	31,8
M10	6030	M10	18,8
	6059	M10	20,8
	6031	M10	21,8
	6032	M10	22,3
	6078	M10	24,8
	6091	M10	25,8
	6033	M10	28,3
6037	M10	35,8	

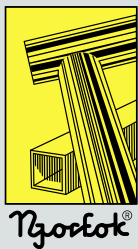

NjorfoK Verbindingssystemen

Inwendige draad

RONDEMOEREN



NJORFOK RONDEMOER

maakt een zeer solide constructie met ronde buizen mogelijk. Door de maatnauwkeurigheid is een moeiteloze montage gegarandeerd.

Al deze produkten leveren wij uit voorraad, loodvrij automaten staal. **Code = Bestelnummer**

Andere oppervlakte behandelingen en /of maten op aanvraag.

RONDEMOER montage voorbeeld

maten in mm

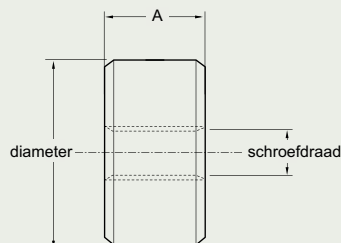
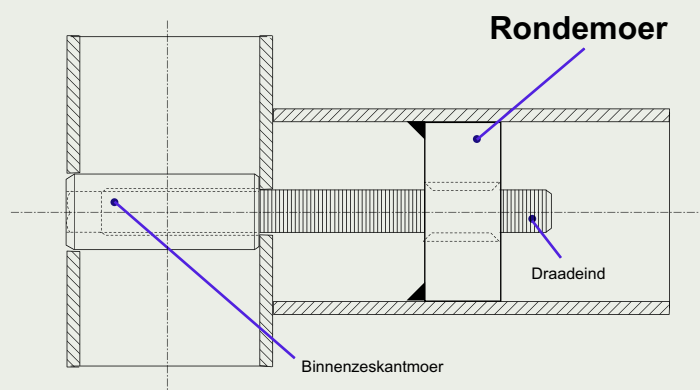

M6 RONDEMOER

Code	diameter	M6	A
16010	16	M6	10
16013	16	M6	15

M8 RONDEMOER

Code	diameter	M8	A
16005	16	M8	10
16007	16	M8	15

M10 RONDEMOER

Code	diameter	M10	A
16018	22	M10	10
16008	28,5	M10	10

SPOR RAMPA MOER

een moer die u altijd recht indraait. Graag demonstreren wij u dit produkt.

Al deze produkten leveren wij uit voorraad, staal verzinkt. **Code = Bestelnummer**

Andere oppervlakte behandelingen en /of maten op aanvraag.

SPOR RAMPA MOER



maten in mm

	Code	schroefdraad	lengte (L)	
M4	16064	M4	10	verzinkt, geel
	16132	M4	20	verzinkt, geel
M5	16067	M5	10	verzinkt, geel
	16026	M5	13	verzinkt, geel
	16028	M5	20	verzinkt, geel
M6	16073	M6	10	verzinkt, geel
	16021	M6	13	verzinkt, geel
	16076	M6	16	verzinkt, geel
	16031	M6	20	verzinkt, geel
	16027	M6	25	verzinkt, geel
M8	16022	M8	13	verzinkt, geel
	16033	M8	18	verzinkt, geel
	16030	M8	25	verzinkt, geel
M10	16023	M10	13	verzinkt, geel
	16029	M10	25	verzinkt, geel

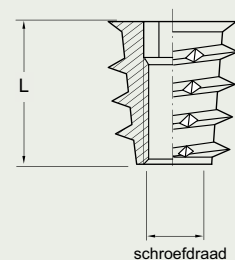

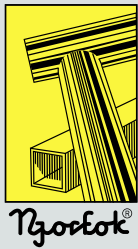

Njorlok Verbindingssystemen

Inwendige draad

NJORFOK RAMPA MOEREN

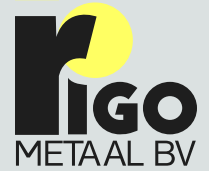

NJORFOK RAMPA MOER, binnenzeskant

correspondeert met al onze andere M6 en M8 produkten.

Al deze produkten leveren wij uit voorraad, staal blank. **Code = Bestelnummer**

Andere oppervlakte behandelingen en /of maten op aanvraag.

NJORFOK RAMPA MOER binnenzeskant



maten in mm

	Code	schroefdraad	diameter	lengte (L)	
M6	16035	M6	12	10	staal ,blank
	16000	M6	12	12	staal ,blank
	16036	M6	12	15	staal ,blank
	16038	M6	12	18	staal ,blank
	16053	M6	12	20	staal ,blank
M8	16039	M8	14	12	staal ,blank
	16001	M8	14	15	staal ,blank
	16071	M8	14	18	staal ,blank

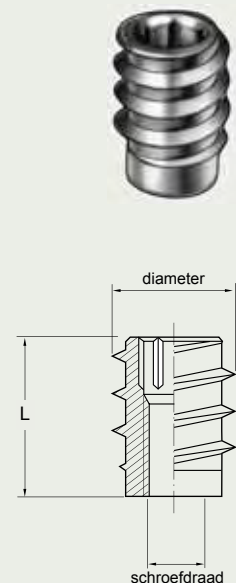

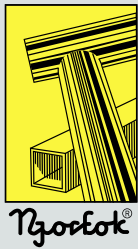

Njorlok Verbindingssystemen

Inwendige draad

INSERTS, INZET- en INSLAG-MOEREN

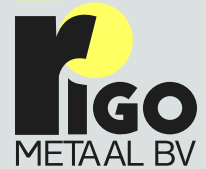

INSERTS

zijn zeer geschikt om snel schroefdraad aan te brengen in zachte materialen zoals kunststof, hout en aluminium.

Code = Bestelnummer

maten in mm

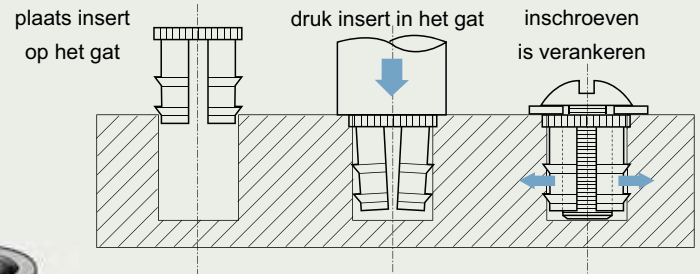

Code	schroefdraad	lengte (L)	
8009	M5	9	messing
8010	M6	9	messing
8022	M8	10	messing

INZETMOER

Deze wordt tot aan de rand in een voorgeboord gat geslagen. De kartel zorgt ervoor dat de moer niet mee kan draaien. Al deze produkten leveren wij uit voorraad, staal blank of staal verzinkt. Andere oppervlakte behandelingen en /of maten op aanvraag.

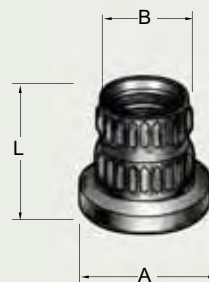

Code	schroefdraad	A	B	L
B2000	M3	8	5,5	8
B2001	M4	8	5,5	8
B2002	M5	10	6,5	10
B2003	M6	12	8,5	12
B2004	M8	15	10,5	12
B2005	M10	18,5	12,5	12

INSLAGMOER

Deze vinden hun toepassing vaak in het blind bevestigen in b.v. stoffeerwerk. De vlijmscherpe weerhaken zorgen voor een stevige verbinding. Al deze produkten leveren wij uit voorraad. Andere maten graag op aanvraag.

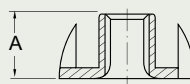

Code	schroefdraad	A
8004	M4	6
8005	M5	8
8006	M6	9
8007	M8	11
8008	M10	12

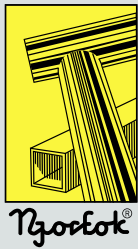

Njorlok Verbindingssystemen

Inwendige draad

DRAADBUSSEN

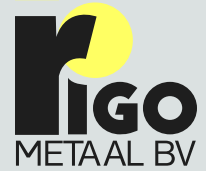

NJORFOK DRAADBUS

Wij vervaardigen ook draadbussen, die uiteraard aangepast kunnen worden aan uw speciale eisen. Al deze produkten leveren wij uit voorraad, staal blank. Code = Bestelnummer
Andere oppervlakte behandelingen en /of maten op aanvraag.

DRAADBUS

maten in mm

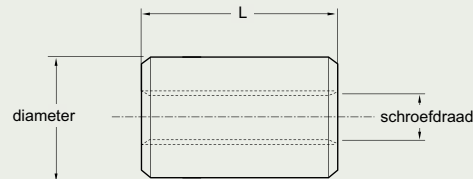

	Code	diameter	schroefdraad	Lengte (L)
diam. 8	3035	8	M5	12
diam. 9	3052	9	M6	11
	3027	9	M6	25
diam. 10	3000	10	M6	9
	3001	10	M6	20
	3002	10	M6	25
	3003	10	M6	28
	3004	10	M6	30
	3005	10	M6	40
diam. 12	3006	12	M8	28
	3039	12	M8	32
diam. 13	3007	13	M8	15
	3008	13	M10	40
diam. 15	3036	15	M6	18
	3048	15	M6	30
	3026	15	M8	25
diam. 16	3009	16	M8	20
	3010	16	M10	20
	3011	16	M12	20

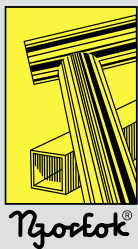

Njorlok Verbindingssystemen

Uitwendige draad

DRAADEINDEN



NJORLOK DRAADEINDEN

worden door ons met de grootste zorg gefabriceerd en zijn uitstekend te combineren met onze andere producten zoals b.v. flensmoeren en multimoeren.

Al deze producten leveren wij uit voorraad, staal verzinkt, kwaliteit 4.6. Code = Bestelnummer

Andere oppervlakte behandelingen en /of maten op aanvraag.

DRAADEIND

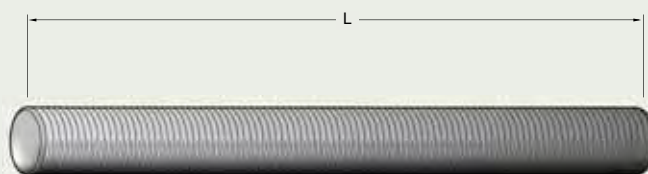

maten in mm

	Code	schroefdraad	lengte (L)		Code	schroefdraad	lengte (L)	
M6	3200	M6	18	M6	3230	M6	130	
	3201	M6	20		3231	M6	135	
	3202	M6	22		3232	M6	140	
	3203	M6	25		3233	M6	160	
	3204	M6	30		3234	M6	200	
	3205	M6	35					
	3206	M6	40		M8	3293	M8	25
	3208	M6	45			3245	M8	30
	3209	M6	50			3235	M8	35
	3210	M6	55			3261	M8	40
	3211	M6	60			3237	M8	45
	3212	M6	65			3238	M8	50
	3214	M6	70			3250	M8	55
	3215	M6	75			3239	M8	60
	3217	M6	80			3259	M8	65
	3219	M6	85			3241	M8	70
	3220	M6	90		3257	M8	75	
3221	M6	95	3266	M8	80			
3222	M6	100	3288	M8	90			
3224	M6	105	3280	M8	100			
3225	M6	110						
3226	M6	115						
3228	M6	120						

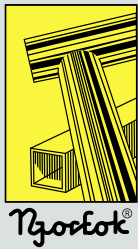

Njorlok Verbindingssystemen

Uitwendige draad

DRAADEINDEN met BINNENZESKANT

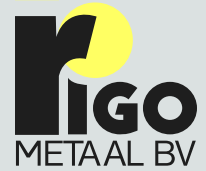

NJORFOK DRAADEINDEN met BINNENZESKANT

worden door ons met de grootste zorg gefabriceerd en zijn uitstekend te combineren met onze andere producten zoals b.v. flensmoeren en multimoeren.

Al deze producten leveren wij uit voorraad, staal gezwart. **Code = Bestelnummer**

Andere oppervlakte behandelingen en /of maten op aanvraag.

DRAADEIND met BINNENZESKANT

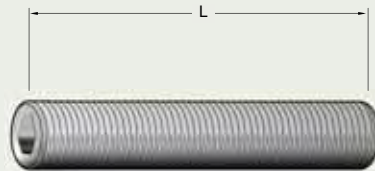

maten in mm

	Code	schroefdraad	lengte (L)
M6	3302	M6	8
	3303	M6	10
	3101	M6	12
	3106	M6	16
	3103	M6	20
	3107	M6	25
	3105	M6	30
	3304	M6	35
	3305	M6	40
	3306	M6	50
	M8	3307	M8
3308		M8	10
3309		M8	12
3102		M8	16
3110		M8	20
3246		M8	25
3311		M8	30
3312		M8	35
3104		M8	40
3108		M8	50

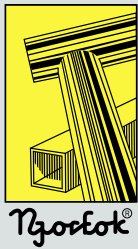

NjorfoK Verbindingssystemen

Uitwendige draad

BINNENZESKANTBOUT

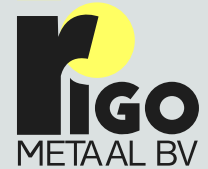

NJORFOK BINNENZESKANTBOUT met CILINDERKOP en VERZONKENKOP

Ter completering van de NJORFOK systemen hebben wij een totaal assortiment binnenzeskantbouten.

Al deze produkten leveren wij uit voorraad, staal gezwart. **Code = Bestelnummer**

Andere oppervlakte behandelingen en /of maten op aanvraag.

BINNENZESKANTBOUT met CILINDERKOP

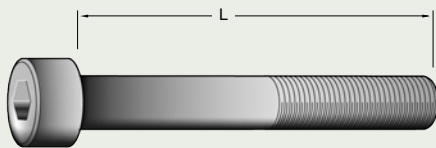

maten in mm

zie ook: CUP

BINNENZESKANTBOUT met VERZONKENKOP

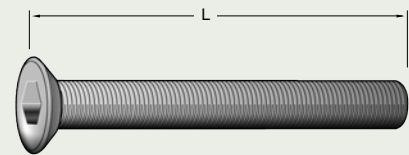

zie ook: ONDERLEGRING

	Code	schroefdraad	lengte (L)
M6	1227	M6	10
	1200	M6	12
	1201	M6	16
	1202	M6	20
	1203	M6	25
	1204	M6	30
	1205	M6	35
	1206	M6	40
	1207	M6	45
	1208	M6	50
	1209	M6	55
	1210	M6	60
	1212	M6	65
	1213	M6	70
	1215	M6	80
	1216	M6	90
	1217	M6	100
M8	1220	M8	60
	1221	M8	70
	1335	M8	80
	1222	M8	100

	Code	schroefdraad	lengte (L)
M6	1339	M6	8
	1301	M6	10
	1302	M6	12
	1304	M6	16
	1305	M6	20
	1306	M6	25
	1307	M6	30
	1308	M6	35
	1309	M6	40
	1310	M6	45
	1311	M6	50
	1312	M6	55
	1313	M6	60
	1333	M6	65
	1314	M6	70
	1337	M6	75
	1315	M6	80
1316	M6	90	
1317	M6	100	
M8	1328	M8	16
	1318	M8	20
	1319	M8	25
	1321	M8	30
	1327	M8	35
	1336	M8	40
	1322	M8	45
	1323	M8	50
	1324	M8	60
	1325	M8	70

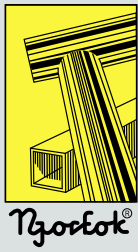

Njorfok Verbindingssystemen

Uitwendige draad

BINNENZESKANTBOUT



NJORFOK BINNENZESKANTBOUT met PLATKOP, BOLKOP en LAGEBOLKOP

Al deze producten leveren wij uit voorraad, staal gezwart.

Code = Bestelnummer

Andere oppervlakte behandelingen en /of maten op aanvraag.

BINNENZESKANTBOUT met PLATKOP

Sleutelwijdte 4 mm Kwaliteit 4.6

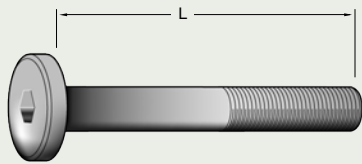

maten in mm

BINNENZESKANTBOUT met BOLKOP

Sleutelwijdte M6 = 4 mm Kwaliteit 4.6
Sleutelwijdte M8 = 5 mm

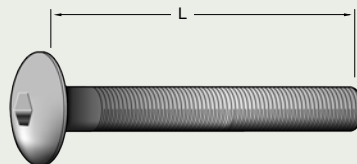

BINNENZESKANTBOUT met LAGE BOLKOP

Kwaliteit 10.9

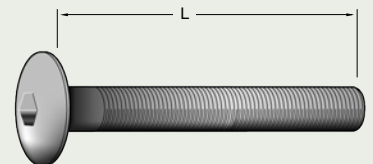

	Code	schroef draad	lengte (L)
M6 kop diam. 15 mm	B3000	M6	12
	B3001	M6	16
	B3002	M6	20
	B3003	M6	25
	B3004	M6	30
	B3005	M6	35
	B3006	M6	40
	B3007	M6	45
	B3008	M6	50
	B3009	M6	60
	B3010	M6	70
	B3011	M6	80
	B3012	M6	90
B3013	M6	100	

CODE + Z = verzinkt

	Code	schroef draad	lengte (L)
M6 kop diam. 15 mm	B3014	M6	12
	B3015	M6	16
	B3016	M6	20
	B3017	M6	25
	B3018	M6	30
	B3019	M6	35
	B3020	M6	40
	B3021	M6	45
	B3022	M6	50
	B3023	M6	60
	B3024	M6	70
	B3025	M6	80
	B3026	M6	90
	B3027	M6	100

M8
kop diam. 17 mm

M8 kop diam. 17 mm	B3072	M8	16
	B3073	M8	20
	B3074	M8	25
	B3075	M8	30
	B3076	M8	35
	B3077	M8	40
	B3078	M8	50
	B3079	M8	60
	B3080	M8	70
	B3081	M8	80
	B3082	M8	90
	B3083	M8	100

CODE + Z = verzinkt

	Code	schroef draad	lengte (L)
M6 kop diam. 10,5 mm	B3028	M6	8
	B3029	M6	10
	B3030	M6	12
	B3031	M6	16
	B3032	M6	20
	B3033	M6	25
	B3034	M6	30
	B3035	M6	35
	B3036	M6	40
	B3037	M6	45
	B3038	M6	50
	B3039	M6	55
	B3040	M6	60

M8
kop diam. 14 mm

M8 kop diam. 14 mm	B3041	M8	8
	B3042	M8	10
	B3043	M8	12
	B3044	M8	16
	B3045	M8	20
	B3046	M8	25
	B3047	M8	30
	B3048	M8	35
	B3049	M8	40
	B3050	M8	45
	B3051	M8	50
	B3052	M8	55
	B3053	M8	60

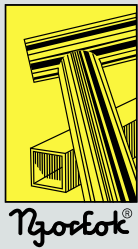

Njorlok Verbindingssystemen

Uitwendige draad

SCHROEVEN



STOKSCHROEF

Een ideale overgang van metrische draad naar houtdraad. Uitstekend te gebruiken met onze andere NJORFOK producten.

Al deze produkten leveren wij uit voorraad, staal verzinkt. **Code = Bestelnummer**
Andere oppervlakte behandelingen en /of maten op aanvraag.



maten in mm

	Code	schroefdraad	lengte (L)
M6	17403	M6	40
	17404	M6	50
	17405	M6	60
M8	17406	M8	50
	17407	M8	60
	17408	M8	70
	17444	M8	80
	17448	M8	120
M10	17439	M10	80

HOUTSCHROEF met BINNENZESKANT

NJORFOK houtschroeven met vlakke kop worden uiteraard met binnenzeskant geleverd.

Al deze produkten leveren wij uit voorraad, staal gezwart. **Code = Bestelnummer**
Andere oppervlakte behandelingen en /of maten op aanvraag.

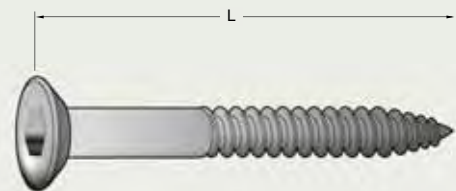

Code	diameter	lengte (L)
7011	6	30
7015	6	50
7017	6	60
7019	6	70

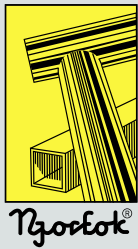

Njorlok Verbindingssystemen

Diversen Njorlok

CUP voor Binnenzeskantbout

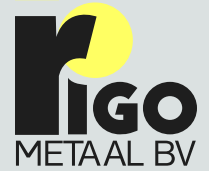

NJORLOK CUP voor Binnenzeskantbout

geeft een goede ondersteuning van de boutkop en een fraai uiterlijk aan de verbinding.

Al deze produkten leveren wij uit voorraad, staal gezwart.
Andere oppervlakte behandelingen en /of maten op aanvraag.

Montage voorbeeld

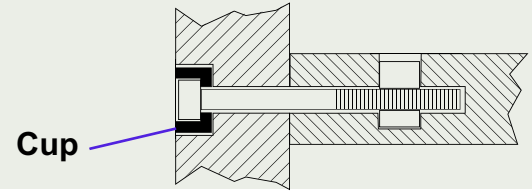

Diam. 12 mm

Code: 2000

staal gezwart

Code = Bestelnummer

maten in mm

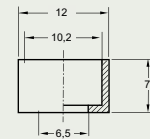

Diam. 14 mm

Code: 2002

staal gezwart

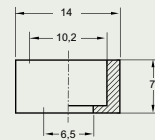

Diam. 16 mm

Code: 2003

staal gezwart

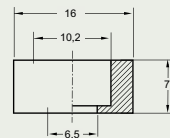

Diam. 18 mm

Code: 5003

staal gezwart

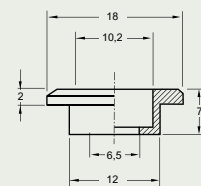

Diam. 20 mm

Code: 2008

staal gezwart

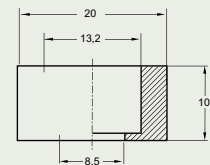

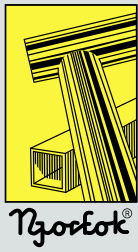

Njorfok Verbindingssystemen

Diversen Njorfok

ONDERLEGRING voor verzonken bouten



NJORFOK ONDERLEGRING voor verzonken kop
doeltreffend en voordelig.

Al deze produkten leveren wij uit voorraad, staal gezwart.
Andere oppervlakte behandelingen en /of maten op aanvraag.

Montage voorbeeld

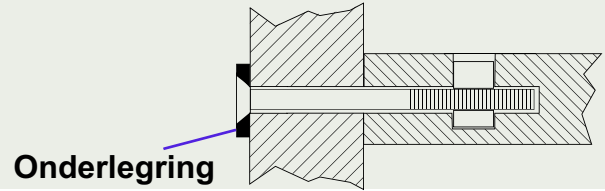

Diam. 13 mm

Code: 14016

staal gezwart

Code = Bestelnummer

maten in mm

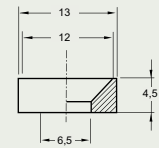

Diam. 14 mm

Code: 14001

staal gezwart

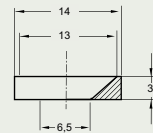

Diam. 16 mm

Code: 14002

staal gezwart

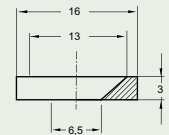

Diam. 17 mm

Code: 14003

staal gezwart

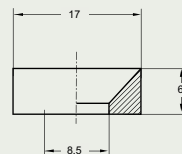

Diam. 18 mm

Code: 14004

staal gezwart

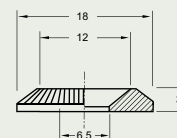

Diam. 25 mm

Code: 14007

staal gezwart

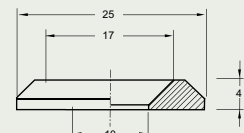

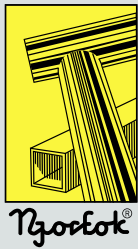

Njorlok Verbindingssystemen

Diversen Njorlok

RINGEN

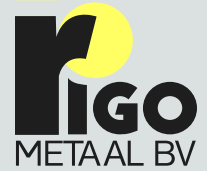

NJORLOK RINGEN

ter completering van ons pakket verbindingssystemen voeren wij tevens sluitringen en veerringen in de meest gangbare maten.

Al deze producten leveren wij uit voorraad. **Code = Bestelnummer**

Andere oppervlakte behandelingen en /of maten op aanvraag.

SLUITRINGEN



maten in mm

Code	voor schroefdraad	
S2000	M3	staal verzinkt
S2001	M4	staal verzinkt
S2002	M5	staal verzinkt
S2003	M6	staal verzinkt
S2004	M8	staal verzinkt
S2005	M10	staal verzinkt

VEERRINGEN

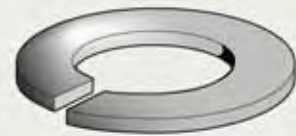

Code	voor schroefdraad	
S2006	M3	staal gezwart
S2007	M4	staal gezwart
S2008	M5	staal gezwart
S2009	M6	staal gezwart
S2010	M8	staal gezwart
S2011	M10	staal gezwart

BINNENZESKANT SLEUTEL

tevens leveren wij sleutels in de afmetingen 2-3-4-5-6-8 mm in blanke of vernikkelde uitvoering

Code	A	
1501	4	ongehard
1502	5	ongehard
1505	6	ongehard
1508	8	ongehard

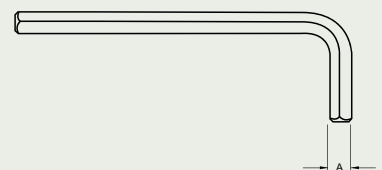

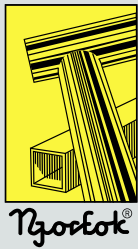

Njorfok Verbindingssystemen

Diversen Njorfok

RADIUSRINGEN



NJORFOK RADIUSRINGEN

geven door hun nauwkeurige passing op rond materiaal een goed draagvlak en een grote stijfheid aan de constructie.

Wij beschikken over de mogelijkheid om deze radiusringen te spuitgieten.

Onze mogelijkheden zetten wij graag in een gesprek nader uiteen.

RADIUSRING montage voorbeelden

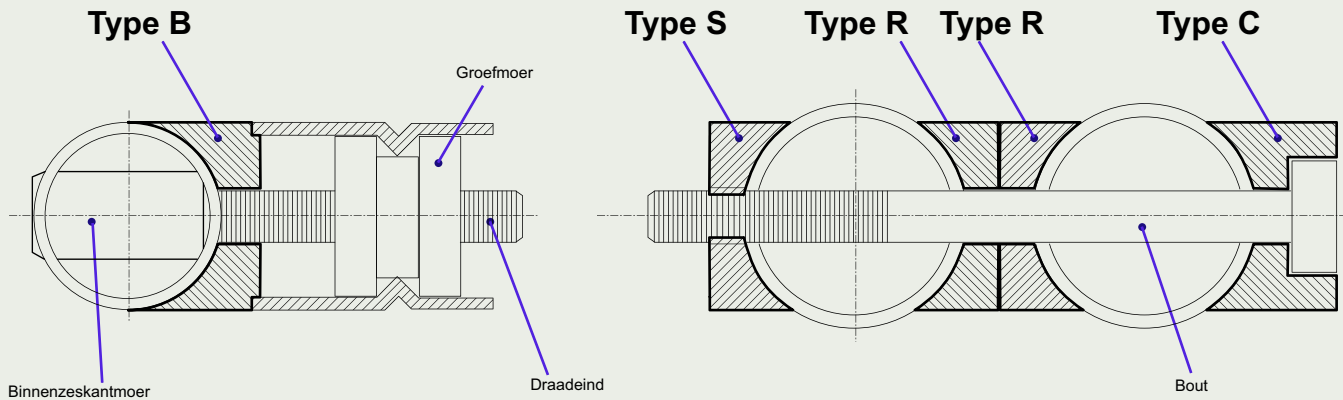

Materiaal:

- staal, evt. met oppervlakte behandeling
- messing
- kunststof

Afmetingen:

- Diameter: 10 t/m 32 mm
- Radius: 5 t/m 16 mm

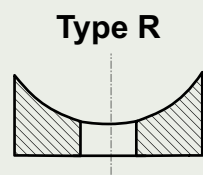
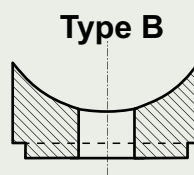
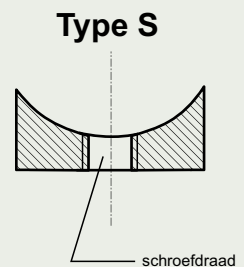
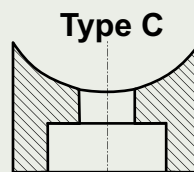

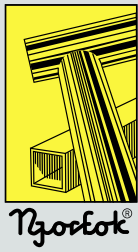

Njorfok Verbindingssystemen

Diversen Njorfok

PRODUKTEN uit Plaatmateriaal

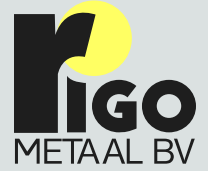

Wij leveren diverse onderdelen uit plaatmateriaal
Al deze produkten leveren wij uit voorraad. **Code = Bestelnummer**
Andere oppervlakte behandelingen en /of maten op aanvraag.

ACHTERWANDSTEUN

Code: 6 dikte 2 mm
Code: 7 dikte 3 mm

standaard materiaal
plaatmateriaal, gezwart

maten in mm

Code + Z = verzinkt

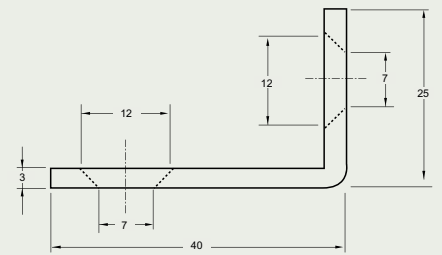

HOEKJE

Code: 7006 verzinkt

standaard materiaal
plaatmateriaal, verzinkt

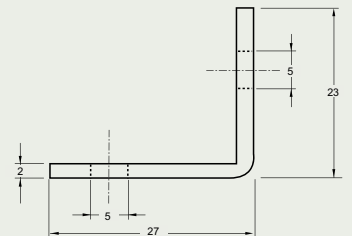

HOEKJE met pal

Code: 1552 verzinkt

Hoekje voorzien
van pal t.b.v. blad bevestiging
standaard materiaal
plaatmateriaal, verzinkt

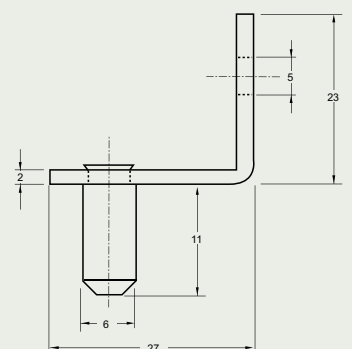

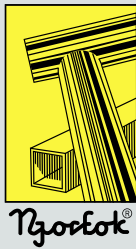

Njorlok Verbindingssystemen

Diversen Njorlok

AFSTANDBUSSEN

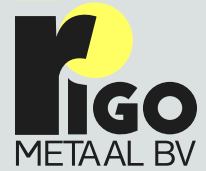

NJORFOK AFSTANDBUSSEN

zijn nauwkeurig van lengte en passen om een bout of draadeind. Ze geven u de mogelijkheid om 2 platen zgn. zwevend te monteren. Wij maken elke gewenste maat volgens uw specificaties.

Al deze produkten leveren wij uit voorraad, staal verzinkt. **Code = Bestelnummer**

Andere oppervlakte behandelingen en /of maten op aanvraag.

AFSTANDBUS

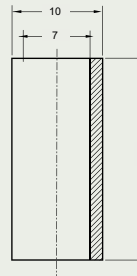

maten in mm

Code	Buiten diameter	Binnen diameter	Lengte (L)
13	10	7	3
56	10	7	4
14	10	7	5
15	10	7	6
74	10	7	7,5
16	10	7	10
76	10	7	10,5
62	10	7	11
69	10	7	12,5
61	10	7	13
17	10	7	15
18	10	7	20
71	10	7	23
19	10	7	24
57	10	7	25
21	10	7	30

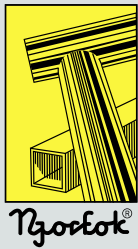

Njorfok Verbindingssystemen

Diversen Njorfok

STELVOETEN en toebehoren

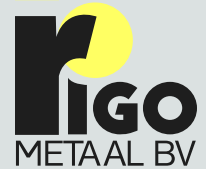

Diverse stelvoeten en toebehoren

voor het stellen van bijvoorbeeld: aanbouwelementen, systeemmeubelen en kasten

Al deze produkten leveren wij uit voorraad. **Code = Bestelnummer**

Andere oppervlakte behandelingen en /of maten op aanvraag.

STELVOET 0230

Een gedraaide stelvoet van staal of messing

Code: 17215	diam. 30 x M8	staal gezwart
Code: 17203	diam. 30 x M10	staal gezwart
Code: 17212	diam. 30 x M10	messing blank

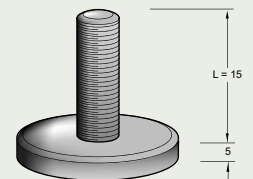

maten in mm

DRAADBUS 0230

Een stalen draadbus voorzien van een kartel voor extra grip

Code: 3009	diam. 16 x M8	staal blank
Code: 3010	diam. 16 x M10	staal blank

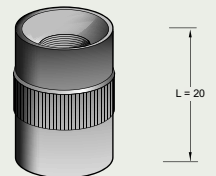

STELVOET E10 ...

Stelvoet voor het waterpas stellen van kasten etc. staal verzinkt.

Tevens te voorzien van een kunststof beschermkapje.(naturel)

Code: E1004	M8	lengte 50
Code: E1006	M8	lengte 70
Code: E1015	M10	lengte 70
Code: E1016	M10	lengte 80
Code: E1017	M10	lengte 100

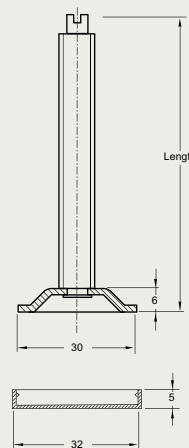

kunststof beschermkapje
Code: E1018 naturel

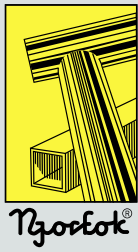

Njorfok Verbindingssystemen

Diversen Njorfok

STELVOETEN en toebehoren

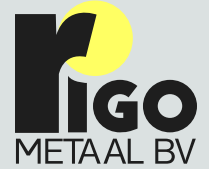

Diverse stelvoeten en toebehoren

voor het stellen van bijvoorbeeld: aanbouwelementen, systeemmeubelen en kasten

Al deze produkten leveren wij uit voorraad. **Code = Bestelnummer**

Andere oppervlakte behandelingen en /of maten op aanvraag.

HOEKSTUK

Code: E20018 M8
Code: E200110 M10

Voor de bevestiging aan uw meubel.

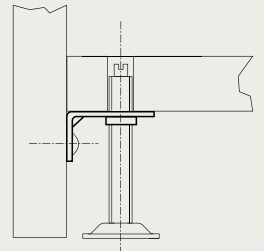
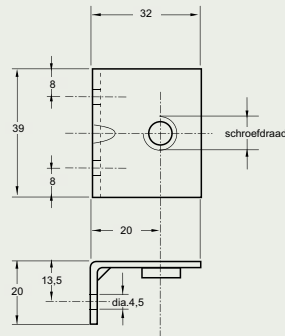

PLAAT

Code: E20028 M8
Code: E200210 M10

Voor de bevestiging aan uw meubel.

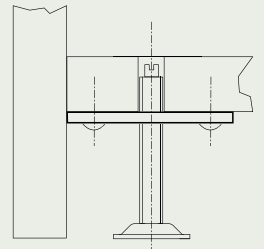
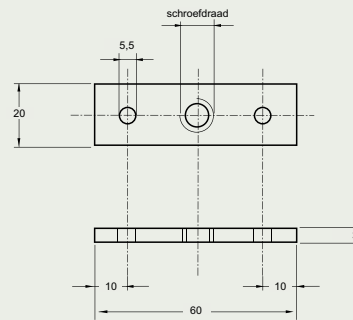

INSLAGMOER

Code: 8007 M8
Code: 8008 M10

Voor de bevestiging aan uw meubel

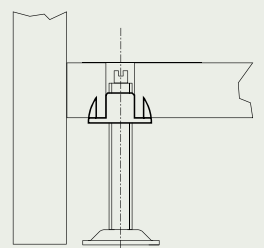
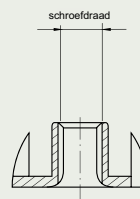

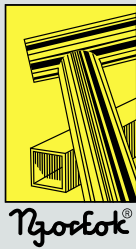

Njorfok Verbindingssystemen

Diversen Njorfok

STELVOETEN en toebehoren

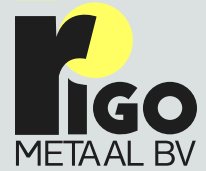

Diverse stelvoeten en toebehoren

voor het stellen van bijvoorbeeld: aanbouwelementen, systeemmeubelen en kasten

Al deze produkten leveren wij uit voorraad. **Code = Bestelnummer**

Andere oppervlakte behandelingen en /of maten op aanvraag.

DUBBELE HOEK

Code: E20048 M8
Code: E200410 M10

Voor de bevestiging aan uw meubel.

maten in mm

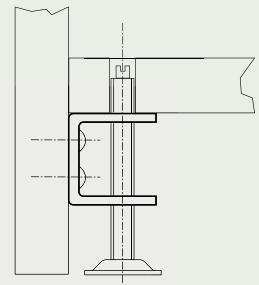
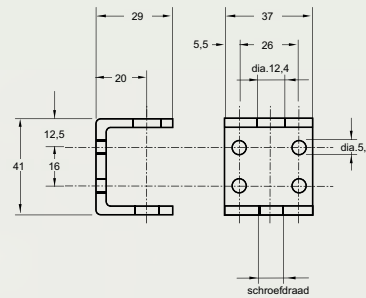

KUNSTSTOFVOET

Kunststof stelvoet met verzinkte draadstift.

Code	Voet		Draadstift	
	diameter	dikte	schroefdraad	lengte
E3001	20	8	M6	17
E3002	20	8	M8	17
E3003	24	8	M6	27
E3004	24	8	M8	17
E3007	34	8	M10	16



KUNSTSTOFVOET

Kunststof stelvoet met verzinkte draadstift.

Code	Voet		Draadstift	
	zijde	dikte	schroefdraad	lengte
E4003	25 x 25	8	M8	18
E4004	25 x 25	8	M10	16
E4005	25 x 25	8	M10	30



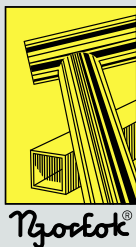

Glaslijmdoppen

Als producent van glaslijmdoppen kunnen wij u elke gewenste dop aanbieden in RVS en aluminium.

Dankzij de nabewerkte kopvlakken is een perfecte verlijming mogelijk aan diverse glassoorten.

Wij leveren onderstaande glaslijmdoppen uit voorraad en ook volgens uw specificatie met een korte levertijd, desgewenst in kleine aantallen. **Code = Bestelnummer**

GLASLIJMDOPPEN

maten in mm

Code	Diameter	schroefdraad	hoogte	
2211-1	30	M6	10	RVS303
2211-2	40	M8	10	RVS303
2211-3	60	M10	10	RVS303



SPOR PRINCIPE voorbeeld

HET SPOR PRINCIPE

Door een kracht te laten werken in richting **A** ontstaat er een kracht **B** haaks op de richting van kracht **A**

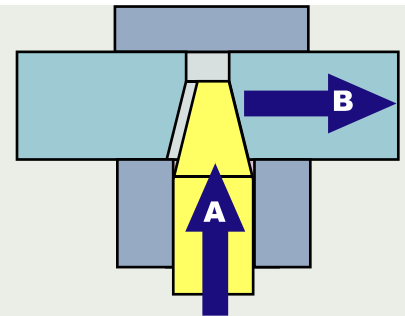

SPOR SYSTEEM

HET SPOR SYSTEEM is ontworpen voor constructies waaraan naast hoge trekvastheden ook eisen t.a.v. de vormgeving worden gesteld. Door de specifieke krachtontbinding ontstaat een aantrekkkracht welke haaks staat op de spankracht van de schroef. Het SPOR systeem kan toegepast worden in hout en buis constructies en combinaties daarvan. Omdat het aantal toepassingen zo groot is en nog steeds toeneemt heeft RIGO metaal BV zich de productie capaciteit verschaft om het SPOR Systeem zelf te kunnen produceren en dus aan te passen aan uw eisen.

Voor het maken van een SPOR SYSTEEM verbinding zijn de volgende onderdelen nodig:

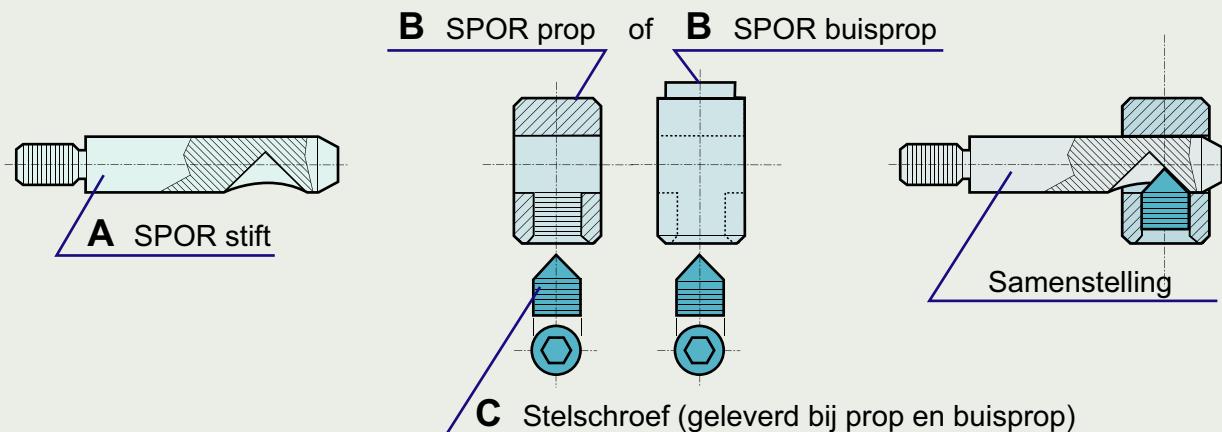

SPOR montage voorbeelden

Hieronder vindt u enige montage voorbeelden.

De bevestiging van de SPOR Stift aan het verticale deel van de constructie is met opzet niet aangegeven aangezien de mogelijkheden hiervoor legio zijn.

MONTAGE VOORBEELD 1

SPOR systeem in hout
m. b. v. SPOR prop

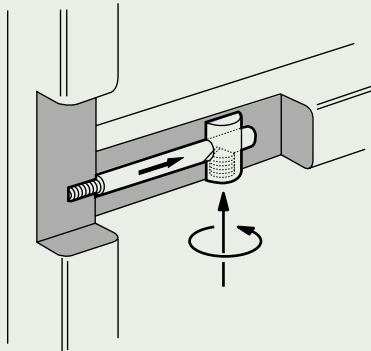

MONTAGE VOORBEELD 2

SPOR systeem in buis
m. b. v. SPOR buisprop

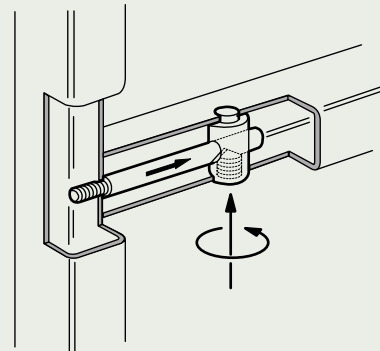

MONTAGE VOORBEELD 3

SPOR systeem als doorverbinding.
Lengte aan te passen aan uw
specifieke eisen.

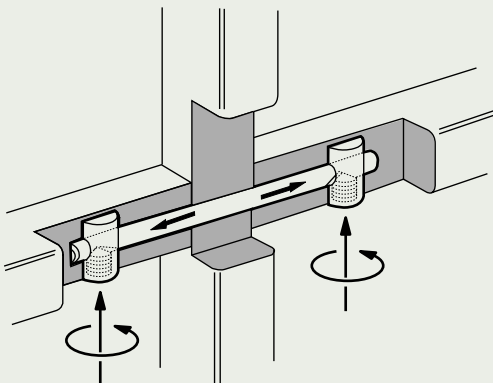

MONTAGE VOORBEELD 4

SPOR systeem als hoekconstructie
m. b. v. SPOR hoekstift

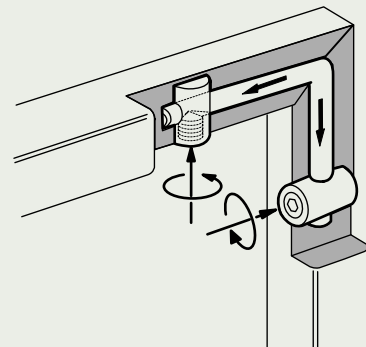

SPOR ONDERDELEN

Hieronder vindt u de onderdelen welke nodig zijn voor het maken van de diverse SPOR verbindingen. Al deze produkten leveren wij uit voorraad, staal gezwart. **Code = Bestelnummer**
Andere oppervlakte behandelingen en /of maten op aanvraag.

SPOR STIFT, M6

Code	Lengte (L)	A	diameter
17508	40	20	8
17509	45	25	8
17510	50	30	8
17511	55	35	8
17512	60	40	8
17513	65	45	8
17514	70	50	8

maten in mm

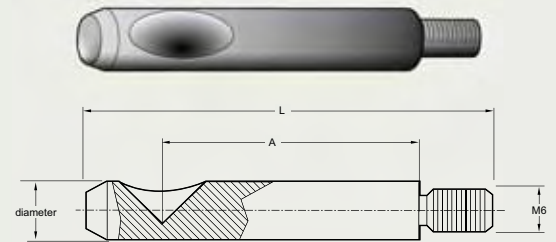

SPOR PROP, Diam. 12 inclusief Stelschroef

Code	Lengte (L)	A	diameter
17559	14	8	12
17515	16	9	12
17516	18	10	12
17530	19	8	12
17517	20	11	12
17518	22	12	12
17531	22	14	12
17519	25	14	12

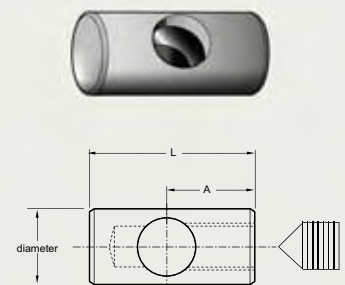

SPOR BUISPROP, Diam. 12 inclusief Stelschroef

Code	Lengte (L)	A	B
17522	16,5	2,2	10
17523	20,5	2,2	10
17524	25,5	2,2	10
17525	30,5	2,2	10
17526	35,5	2,2	10
17527	40,5	2,2	10

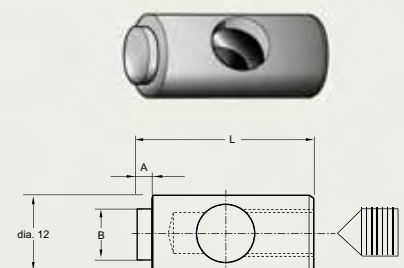

SPOR KOPPELSTIFT, Diam. 8

Code	Lengte (L)	A	diameter
17535	80	50	8
17541	96	66	8
17532	106	76	8
17534	120	90	8
17533	130	100	8

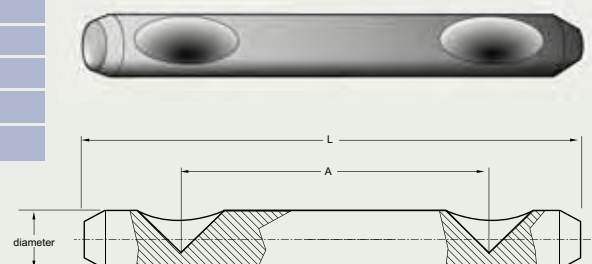

SPOR ONDERDELEN

Hieronder vindt u de onderdelen welke nodig zijn voor het maken van de diverse SPOR verbindingen. Al deze producten leveren wij uit voorraad. **Code = Bestelnummer**
Andere oppervlakte behandelingen en /of maten op aanvraag.

SPOR HOEKSTIFT

staal gezwart

Code	A	B	diameter
17548	34	24	8
17552	42	32	8
17520	51	36	8

maten in mm

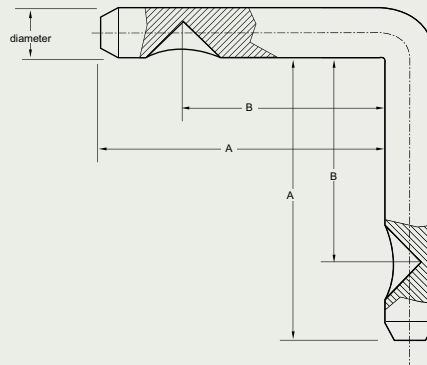

SPOR STELSCHROEF

M8
geleverd bij SPOR (buis)prop

staal gezwart

Code	Schroefdraad	Lengte (L)
17554	M8	8
17543	M8	10
17546	M8	12
17538	M8	16
17566	M8	20



SPOR RAMPA MOER

Een RAMPA moer die u altijd recht indraait.

Materiaal: ZAMAC

Code	schroefdraad	lengte (L)
16073	M6	10
16021	M6	13
16076	M6	16
16031	M6	20
16027	M6	25

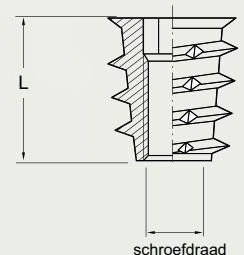



maten in mm

BOORMATEN SPOR SYSTEEM

Bij het boren van de gaten t.b.v. het SPOR systeem moet u op de volgende punten letten.
 Voor de bevestiging van de SPOR stift moet u zorgen voor tenminste **(D) 10 mm, M6** draad.
 Zie hiervoor ook de gegevens van de Rampa moeren.
 De plaats van de SPOR prop of de SPOR buisprop bepaalt u door **3 mm** op te tellen bij **maat A** van de SPOR stift.
 De lengte van het gat voor de SPOR stift moet minstens maat **A + 12 mm** zijn.

SPOR STIFT

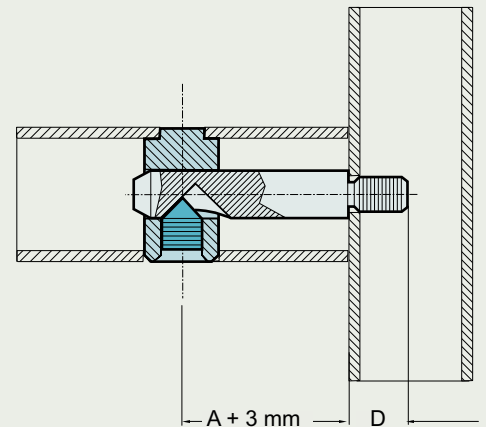
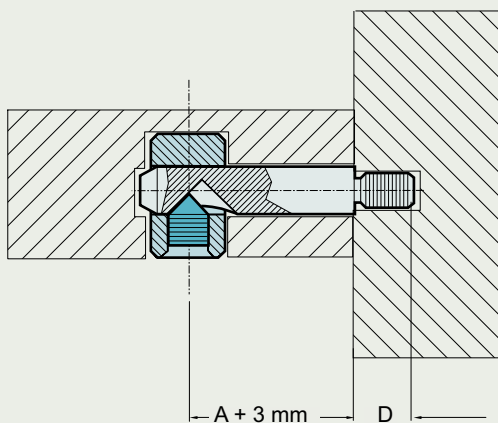
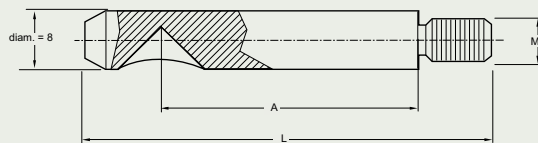

SPOR KOPPELSTIFT

Bij het boren van de gaten t.b.v. de SPOR koppelstift kunt u op 2 manieren te werk gaan.

Indien u eerst 1 stelschroef vast wilt draaien en daarna met de andere de constructie op spanning wilt brengen, moet u als boormaat **A + 3 mm** aanhouden.

Indien u de 2 stelschroeven beide wilt gebruiken, teneinde meer stelmogelijkheid te hebben, moet u als boormaat **A + 6 mm** aanhouden.

De boordiepte voor de lengte is dan **L + 4 mm**

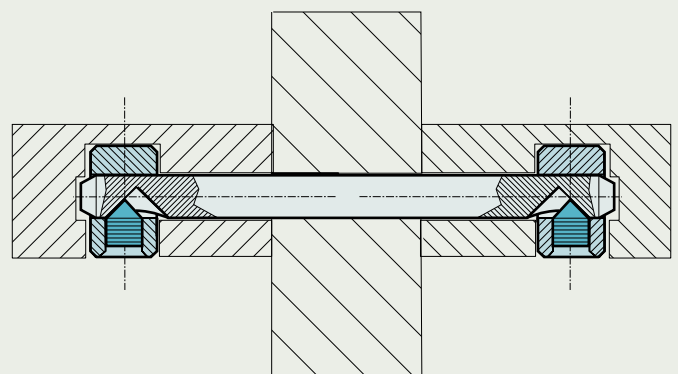
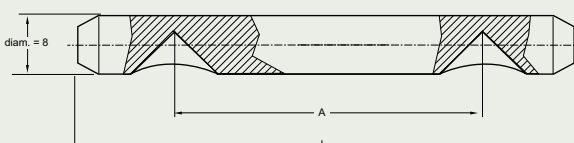



maten in mm

BOORMATEN SPOR SYSTEEM

SPOR HOEKSTIFT

Bij het boren van de SPOR hoekstift moet u er op letten dat de gebruikte SPOR prop op afstand **B + 3 mm** zit.

U moet **B** meten op de plaats waar de SPOR stift in het verstek geboord zit. Diepteboring **A + 5 mm** eveneens gemeten vanaf het verstek.

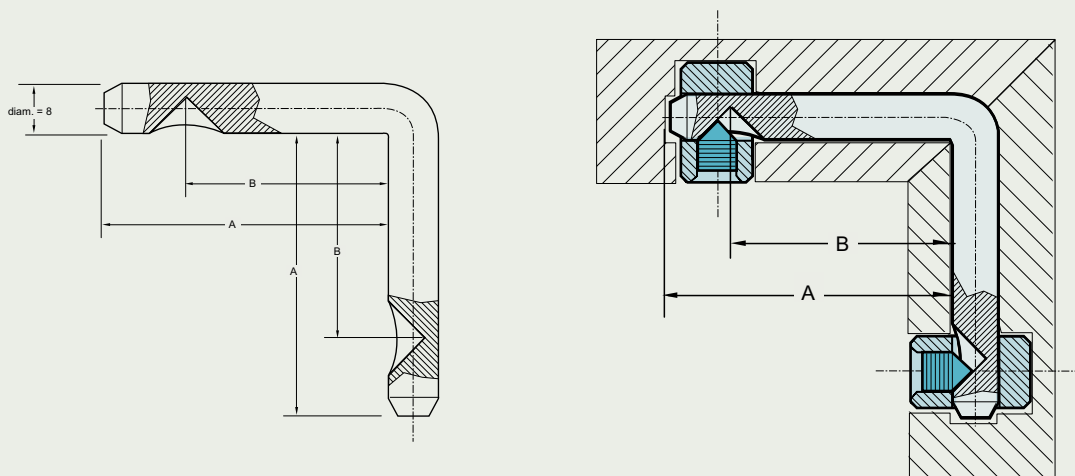

BOORMATEN SPOR RAMPA MOEREN

Draad	Dia C	Dia A	B	D
M4	8,5	5,9	L + 2 mm	1
M5	11,5	7,8	L + 2 mm	1
M6	12,5	8,9	L + 2 mm	1,3
M8	14,5	10,8	L + 2 mm	1,3
M10	16,2	12,8	L + 2 mm	1,3

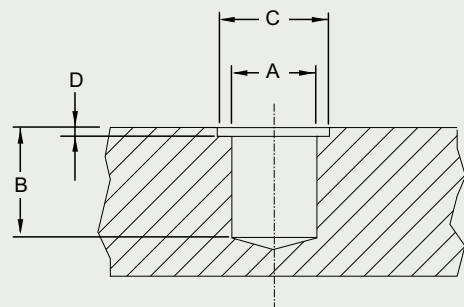

BOORMATEN BZK RAMPA MOEREN

Draad	Dia A	B
M6	10	L + 2 mm
M8	12	L + 2 mm

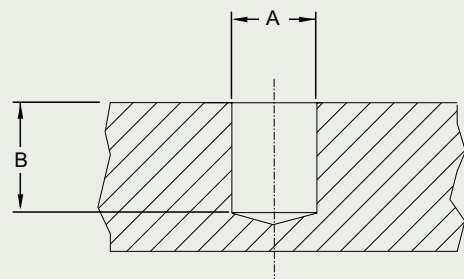

Al deze maten gelden als richtmaat. Wij raden u aan de exacte maat proefondervindelijk te bepalen daar deze afhankelijk is van de gebruikte materialen.

's-Hertogenbosch

Udenhout

RIGO METAAL BV

Brabantse Hoek

Kreitemolenstraat

Nijverheidsweg

N65

Tilburg

Oisterwijk

RIGO
METAAL BV



Rigo Metaal bv
Nijverheidsweg 5
5071 NL Udenhout

Tel. (013) 511 16 88
Fax. (013) 511 18 83

E-mail: info@rigometaal.nl
Website: www.rigometaal.nl